



Catalogue
FOOD SERVICE
Chapter
COOKING

Specific model
M-G915 BM NG 230V 1N 50Hz

19075830

12/07/2023

DENOMINATION:

Indirect heating boiling pans with bain marie system, NG gas 50 Hz, 150 L capacity, 900 range.

DESCRIPTION :

- Surface tops manufactured in 2 mm thick AISI-304 stainless steel.
- Laser-cut joints, automatic welding and polishes. Screws hidden from view.
- Double walled lid balanced by means of a hinge with front handle, with diagonal opening to 75° which allows the lid to be kept open in any position.
- Well stamped into the surface top by robotic welding, manufactured in AISI-304 stainless steel, with the bottom of the well in AISI-316L stainless steel.
- Well filling with hot or cold water by electrovalve, activated with a single switch located on the front panel.
- Well emptying by 2" safety valve with handle in athermic material and safe and effortless handling.
- Robust and reliable filter for draining the well manufactured in AISI-304 stainless steel. Easily extractable.
- Controls with protective base and system against water infiltration.
- High temperature enamelled cast iron flue protector.
- Access to the components from the front.
- Machines with IPX5 grade water protection."
- "- Group of optimised combustion stainless steel tubular burners, controlled by energy regulator and by pressure switch.
- Control by energy regulator and by pressure switch, permitting lower water and energy consumption.
- Ignition of group of burners by spark train. "
- "- Bain marie chamber around the well, with automatic filling system when the machine is connected.
- Automatic chamber level control with quadruple security: pressure switch to control the pressure in the chamber, overpressure security valve, thermostat to limit overheating in the chamber and pressure gauge incorporated into the surface top.
- Automatic flushing of the chamber.
- Heating at the bottom of the pan acts on the water in the surrounding chamber, meaning that the saturated steam generated at a temperature of 107 °C heats the bottom and sides of the well in a uniform manner. The temperature reached is lower than that obtained with direct heating.
- Stamped pan floor to avoid deformations.
- Indicator light to show when the machine is connected and when it is heating. "

POSSIBLE OPTIONS :

- 230 1N- Transformation A 230 V single phase
- 230 III - A 230 V three-phase transformation without neutral
- Marine Transformation for boat - Tilting and boiling pans

POSSIBLE ACCESSORIES :

- ACCESSORIES BOILING PANS KORE
- KORE WHEELS
- TALL CHIMNEY KORE

DIMENSIONS



X Width	800 mm	X Gross width	840 mm
Y Depth	930 mm	Y Gross depth	1022 mm
Z Height	850 mm	Z Gross height	1255 mm
Net Weight	120,0 kg	Gross Weight	150,0 kg
Net volume	0,630 m3	Gross volume	1,077 m3

ELECTRICITY TECHNICAL SPECIFICATIONS

Electric power	0,100 kW
Amperage (A)	2A
Voltage	230V - 1N
Electric frequency	50Hz

GAS TECHNICAL SPECIFICATIONS

Gas type	NG
Gas power	24,00 kW
Gas consumption	2,500 m3/h
Regulated	NG G20/G25/G25.1 20/25/25 mbar

WATER TECHNICAL SPECIFICATIONS

Pressure	H2O: 200-400kPa(2-4bar)
----------	-------------------------

CONNECTIONS TECHNICAL SPECIFICATIONS

Gas diameter 1	R3/4"
Water inlet diameter	3/4"





Catalogue
FOOD SERVICE
Chapter
COOKING

Specific model
M-G915 BM NG 230V 1N 50Hz

19075830

12/07/2023

M-G910 BM

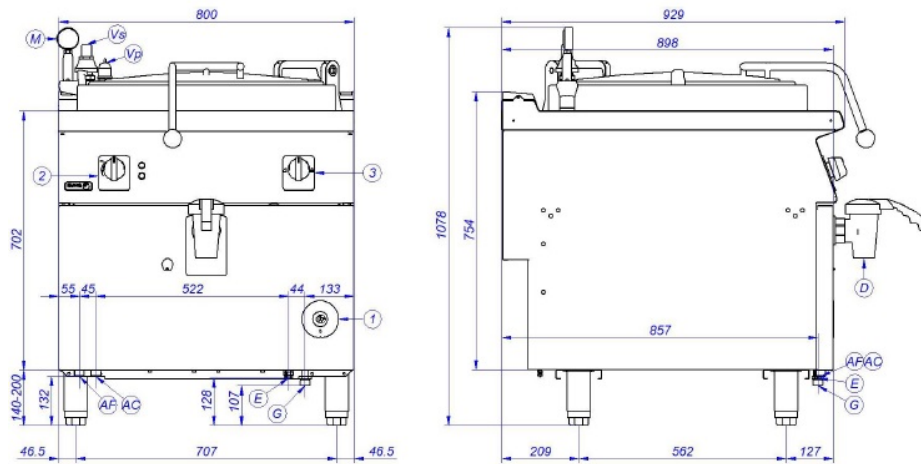

M-G915 BM

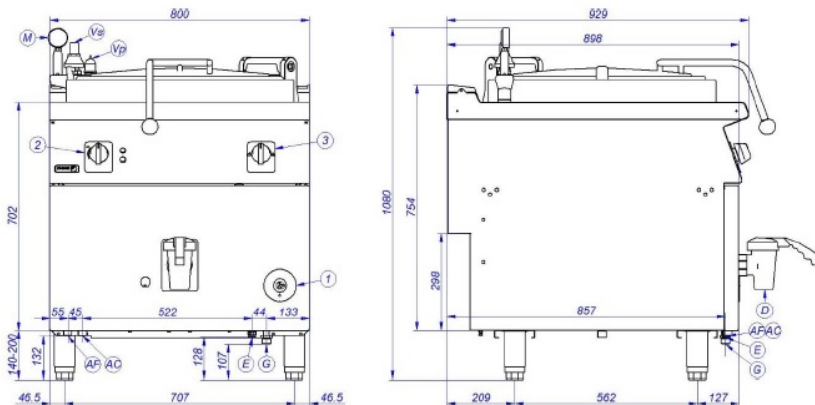

- | | | |
|----|--------------------------|---------------------|
| AF | Entrada de Agua Fría | Cold water Inlet |
| AC | Entrada de Agua Caliente | Hot water Inlet |
| E | Conexión eléctrica | Electric connection |
| D | Desagüe | Drainage |
| G | Entrada de Gas | Gas Inlet |
| M | Manómetro | Manometer |
| Vs | Válvula de seguridad | Safety valve |
| Vp | Válvula de presión | Pressure Valve |
| 1 | Grifo válvula de gas | Gas valve tap |
| 2 | Regulador de energía | Energy regulator |
| 3 | Conmutador de agua | Water switch |