



HAND BLENDER XM-22

Professional immersion blender. 300 W.



DYNAMIC PREPARATION
COMMERCIAL HAND BLENDERS

SALES DESCRIPTION

- ✓ Variable speed motor block.
- ✓ 300 mm detachable arm.
- ✓ Designed for continuous use in recipients of up to 15 l.

All-in-one

- ✓ Professional hand blender designed for carrying out different preparations without the need for add-on tools.
- ✓ Professional Y-blade, made from tempered steel and with a long-duration cutting edge.
- ✓ Vario-speed: variable speed.
- ✓ Designed to work in recipients of up to 15 litres.

Maximum comfort for the user

- ✓ Compact design: logical and manageable size.
- ✓ Ergo-design & bi-mat-grip: external casing made in two materials for an ergonomic hold. Anti-slip grip. Optimum inclination of handle, minimising fatigue.
- ✓ Click-on-arm: detachable arm with fast and secure closure.
- ✓ Hood designed to avoid splashes.
- ✓ Intuitive use: very simple operation. Warning light when the machine is connected to the mains.

Built to last

- ✓ Professional performance: capable of carrying out prolonged work without the casing overheating.
- ✓ Life-plus: equipped with a motor which has passed all of the most demanding usage tests.
- ✓ Studied geometry: casing designed to avoid rolling and falling.
- ✓ Easy to clean: detachable arm, can be cleaned under the tap.
- ✓ Approved by NSF: guaranteed safety and hygiene.

INCLUDES

- ✓ Variable speed motor block.
- ✓ MA-22 mixer arm.
- ✓ Wall mount.

OPTIONAL

- MA-21 mixer arm.
- Whisk BA-20.

ACCESSORIES

- Motor unit MM-20V
- Whisk BA-20
- Mixer arms MA-20

SPECIFICATIONS

Total loading: 300 W
 Maximum recipient capacity: 15 l
 Maximum working depth: 203 mm
 Motor speed: 1500 - 15000 rpm
 Blade diameter: 50 mm
 Blade guard diameter: 82 mm

Length

Liquidising arm length: 300 mm
 Total length: 564 mm

Net weight: 2.39 kg
 Noise level (1m.): <80 dB(A)

Crated dimensions

440 x 375 x 105 mm
 Gross weight: 3.25 kg

AVAILABLE MODELS

3030626 Immersion blender XM-22 230/50-60/1

* Ask for special versions availability



product sheet
updated 20/01/2024



HAND BLENDER XM-22

Professional immersion blender. 300 W.



DYNAMIC PREPARATION
COMMERCIAL HAND BLENDERS

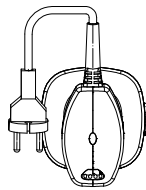
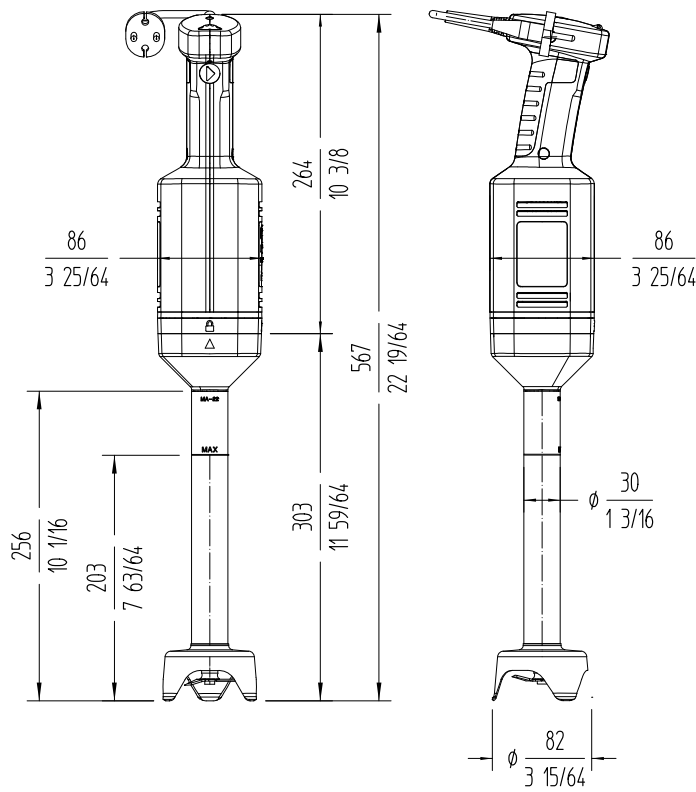

sammic | www.sammic.com
Food Service Equipment Manufacturer

Polígono Basarte, 1. phone +34 943 15 72 36
20720 Azkoitia, Spain sales@sammic.com



Project	Date
Item	Qty
Approved	

product sheet
updated 20/01/2024