



**Catalogue**  
FOOD SERVICE  
**Chapter**  
COOKING

**Specific model**  
M-G920 LPG 230V 1N 50Hz

19075836

12/07/2023

**DENOMINATION:**

Direct heating boiling pan, LPG gas 50 Hz, 200 L capacity, 900 range.

**DESCRIPTION :**

- "- Surface tops manufactured in 2 mm thick AISI-304 stainless steel.
- Laser-cut joints, automatic welding and polishes. Screws hidden from view.
- Double walled lid balanced by means of a hinge with front handle, with diagonal opening to 75° which allows the lid to be kept open in any position.
- Well stamped into the surface top by robotic welding, manufactured in AISI-304 stainless steel, with the bottom of the well in AISI-316L stainless steel.
- Well filling with hot or cold water by electrovalve, activated with a single switch located on the front panel.
- Well emptying by 2" safety valve with handle in athermic material and safe and effortless handling.
- Robust and reliable filter for draining the well manufactured in AISI-304 stainless steel. Easily extractable.
- Controls with protective base and system against water infiltration.
- High temperature enamelled cast iron flue protector.
- Access to the components from the front.
- Machines with IPX5 grade water protection."
- "- Group of optimised combustion stainless steel tubular burners, controlled by energy regulator and by pressure switch.
- Control by energy regulator and by pressure switch, permitting lower water and energy consumption.
- Ignition of group of burners by spark train. "
- "- Heating from the burners at the bottom of the pan covers the base in a uniform manner, to give progressive heating of the contents of the well.
- Option of regulating the heating by the burners, with different degrees of power.
- Indicator light to show when the machine is connected and when it is heating."

**POSSIBLE OPTIONS :**

- 230 1N- Transformation A 230 V single phase
- 230 III - A 230 V three-phase transformation without neutral
- Marine Transformation for boat - Tilting and boiling pans

**POSSIBLE ACCESSORIES :**

- ACCESSORIES BOILING PANS KORE
- KORE WHEELS
- TALL CHIMNEY KORE

**DIMENSIONS**



X Width	800 mm	X Gross width	840 mm
Y Depth	930 mm	Y Gross depth	1022 mm
Z Height	850 mm	Z Gross height	1255 mm
Net Weight	120,0 kg	Gross Weight	150,0 kg
Net volume	0,630 m3	Gross volume	1,077 m3

**ELECTRICITY TECHNICAL SPECIFICATIONS**

Electric power	0,100 kW
Amperage (A)	2A
Voltage	230V - 1N
Electric frequency	50Hz

**GAS TECHNICAL SPECIFICATIONS**

Gas type	LPG
Gas power	24,00 kW
Gas consumption	1,840 kg/h
Regulated	LPG G30/G31 28-30/37 mbar NG G20/G25/G25.1 20/25/25 mbar

**WATER TECHNICAL SPECIFICATIONS**

Pressure	H2O: 200-400kPa(2-4bar)
----------	-------------------------

**CONNECTIONS TECHNICAL SPECIFICATIONS**

Gas diameter 1	R3/4"
Water inlet diameter	3/4"





**Catalogue**  
FOOD SERVICE  
**Chapter**  
COOKING

**Specific model**  
M-G920 LPG 230V 1N 50Hz

19075836

12/07/2023

**M-G910**

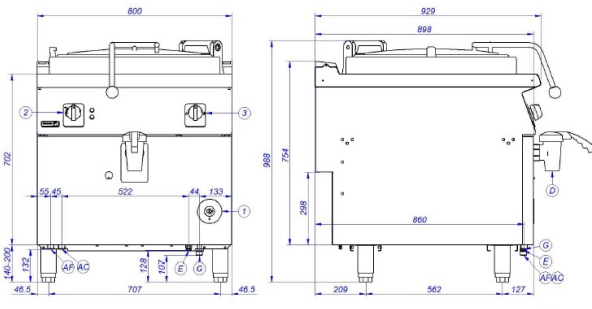

**M-G915**

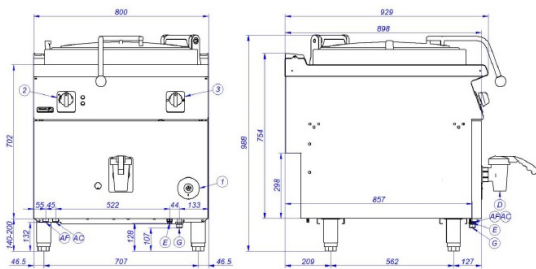

**M-G920**

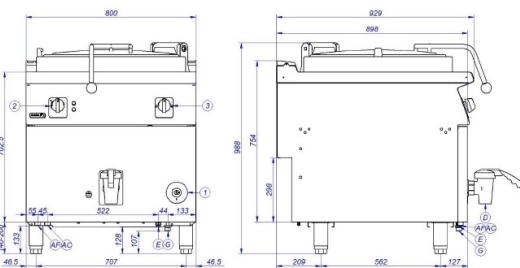

AF	Entrada de Agua Fría	Cold water Inlet
AC	Entrada de Agua Caliente	Hot water Inlet
E	Conexión eléctrica	Electric connection
D	Desagüe	Drainage
G	Entrada de Gas	Gas Inlet
M	Manómetro	Manometer
Vs	Válvula de seguridad	Safety valve
Vp	Válvula de presión	Pressure Valve
1	Grifo válvula de gas	Gas valve tap
2	Regulador de energía	Energy regulator
3	Conmutador de agua	Water switch