



Catalogue
FOOD SERVICE
Chapter
COOKING

Specific model
MP-G915 LPG 230V 1N 60Hz

19075844

12/07/2023

DENOMINATION:

Direct heating boiling pan with pressure operation, LPG gas 60 Hz, 150 L capacity, 900 range.

DESCRIPTION :

- Surface tops manufactured in 2 mm thick AISI-304 stainless steel.
- Laser-cut joints, automatic welding and polishes. Screws hidden from view.
- Double walled lid balanced by means of a hinge with front handle, with diagonal opening to 75° which allows the lid to be kept open in any position.
- Well stamped into the surface top by robotic welding, manufactured in AISI-304 stainless steel, with the bottom of the well in AISI-316L stainless steel.
- Well filling with hot or cold water by electrovalve, activated with a single switch located on the front panel.
- Well emptying by 2" safety valve with handle in athermic material and safe and effortless handling.
- Robust and reliable filter for draining the well manufactured in AISI-304 stainless steel. Easily extractable.
- Controls with protective base and system against water infiltration.
- High temperature enamelled cast iron flue protector.
- Access to the components from the front.
- Machines with IPX5 grade water protection."
- "- Group of optimised combustion stainless steel tubular burners, controlled by energy regulator and by pressure switch.
- Control by energy regulator and by pressure switch, permitting lower water and energy consumption.
- Ignition of group of burners by spark train. "
- "- Heating from the burners at the bottom of the pan covers the base in a uniform manner, to give progressive heating of the contents of the well.
- Option of regulating the heating by the burners, with different degrees of power.
- Indicator light to show when the machine is connected and when it is heating."
- "- Folding and compensated lid, with flange closure.
- Operation with pressure in the cooking well, 0.3 atmospheres.
- Overpressure safety valve on the lid."

POSSIBLE OPTIONS :

- 230 1N- Transformation A 230 V single phase
- 230 III - A 230 V three-phase transformation without neutral
- Marine Transformation for boat - Tilting and boiling pans

POSSIBLE ACCESSORIES :

- KORE WHEELS
- TALL CHIMNEY KORE

DIMENSIONS

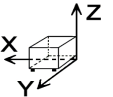

X Width	800 mm	X Gross width	840 mm
Y Depth	930 mm	Y Gross depth	1022 mm
Z Height	850 mm	Z Gross height	1255 mm
Net Weight	120,0 kg	Gross Weight	150,0 kg
Net volume	0,630 m3	Gross volume	1,077 m3

ELECTRICITY TECHNICAL SPECIFICATIONS

Electric power	0,100 kW
Amperage (A)	2A
Voltage	230V - 1N
Electric frequency	60Hz

GAS TECHNICAL SPECIFICATIONS

Gas type	LPG
Gas power	24,00 kW
Gas consumption	1,840 kg/h
Regulated	LPG G30/G31 28-30/37 mbar NG G20/G25/G25.1 20/25/25 mbar

WATER TECHNICAL SPECIFICATIONS

Pressure	H2O: 200-400kPa(2-4bar)
----------	-------------------------

CONNECTIONS TECHNICAL SPECIFICATIONS

Gas diameter 1	R3/4"
Water inlet diameter	3/4"



Catalogue
FOOD SERVICE
Chapter
COOKING

Specific model
MP-G915 LPG 230V 1N 60Hz

19075844

12/07/2023

MP-G910

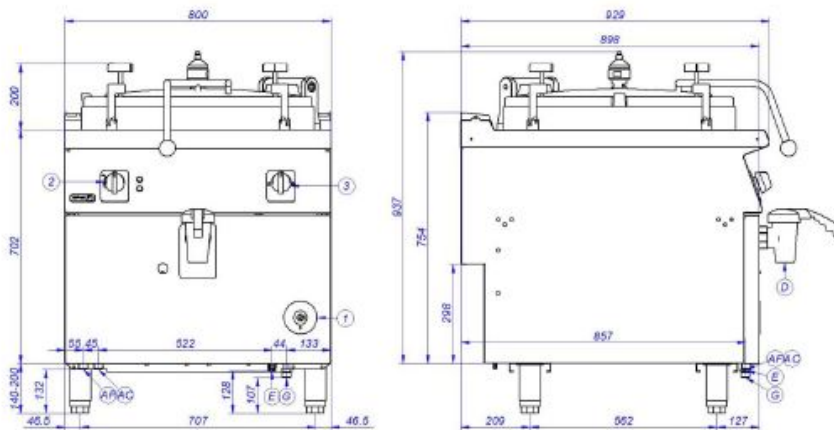

MP-G915 & MP-G920

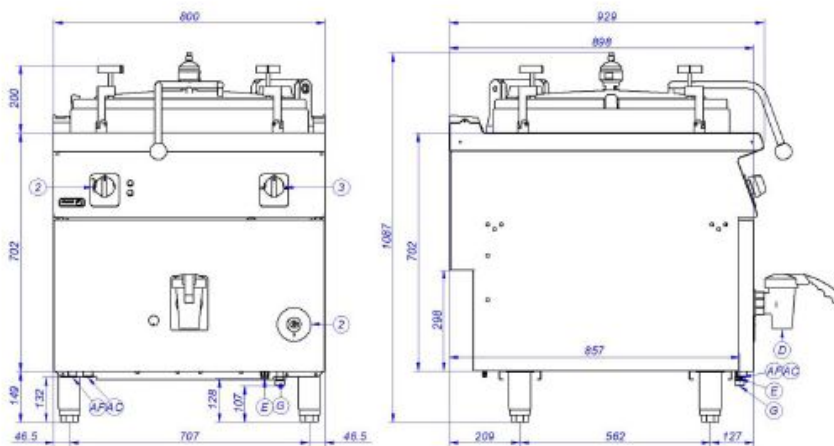

AF	Entrada de Agua Fría	Cold water Inlet
AC	Entrada de Agua Caliente	Hot water Inlet
E	Conexión eléctrica	Electric connection
D	Desagüe	Drainage
G	Entrada de Gas	Gas Inlet
M	Manómetro	Manometer
Vs	Válvula de seguridad	Safety valve
Vp	Válvula de presión	Pressure Valve
1	Grifo válvula de gas	Gas valve tap
2	Regulador de energía	Energy regulator
3	Conmutador de agua	Water switch