



**Catalogue**  
**FOOD SERVICE**  
**Chapter**  
**COOKING**

**Specific model**  
**C-G761 H LPG**

19071463

04/09/2023

**DENOMINATION:**

Gas cookers with oven. LPG. 6 burners, high power. 700 range.

**DESCRIPTION :**

- "- Stamped surface tops manufactured in 1.5 mm thick AISI-304 stainless steel.
- Laser-cut joints and automatic welding. Hidden screws.
- 397 x 580 mm double grates (397 x 290 mm for each burner) enabling the use of large pots and pans. The reduced distance of 75 mm between the central bars makes it possible to use pots with a very small diameter (8 cm), avoiding the risk of smaller pans tipping over.
- The grates are made of RAAF enamelled cast iron (resistant to alkaline and acid products, fire and high temperatures).
- Double-crown burners and diffusers made of nickel-plated cast iron which guarantee an even distribution of heat from the flame to the base of the pans, even for large pans. This therefore prevents heat from building up in a specific point and optimises energy transfer to the product.
- Burners of different strengths to adapt to containers and for use with different foods:
  - 5.25 kW (Ø 100 mm),
  - 8.0 kW(Ø 120 mm),
- Burners are easy to position.
- Low-consumption pilot light and thermocouple located within the body of the burner for greater protection.
- Flexible stainless-steel gas pipes, facilitating internal manipulations in order to make repairs easier.
- Controls with a protective support base and system to prevent water infiltration.
- High-temperature enamelled cast iron flue protector which is flush with the grates therefore improving manoeuvrability, supporting larger containers and increasing the usable surface area.
- Access to components from the front."

**POSSIBLE OPTIONS :**

- Wheels Kit (Factory Assembly)

**POSSIBLE ACCESSORIES :**

- COOKER ACCESSORIES KORE
- KORE WHEELS
- TALL CHIMNEY KORE

**DIMENSIONS**



X Width	1200 mm	X Gross width	1240 mm
Y Depth	730 mm	Y Gross depth	822 mm
Z Height	850 mm	Z Gross height	1255 mm
Net Weight	138,0 kg	Gross Weight	160,0 kg
Net volume	0,740 m3	Gross volume	1,279 m3

**ELECTRICITY TECHNICAL SPECIFICATIONS**

Voltage N/A - N/A

**GAS TECHNICAL SPECIFICATIONS**

Gas type LPG  
 Gas power 56,60 kW  
 Gas consumption 4,095 kg/h  
 Regulated LPG G30/G31 28-30/37 mbar  
 NG G20/G25/G25.1 20/25/25 mbar

**CONNECTIONS TECHNICAL SPECIFICATIONS**

Gas diameter 1 R.3/4"G



**Catalogue**  
FOOD SERVICE  
**Chapter**  
COOKING

**Specific model**  
C-G761 H LPG

19071463

04/09/2023

## C-G761 & C-G761 H

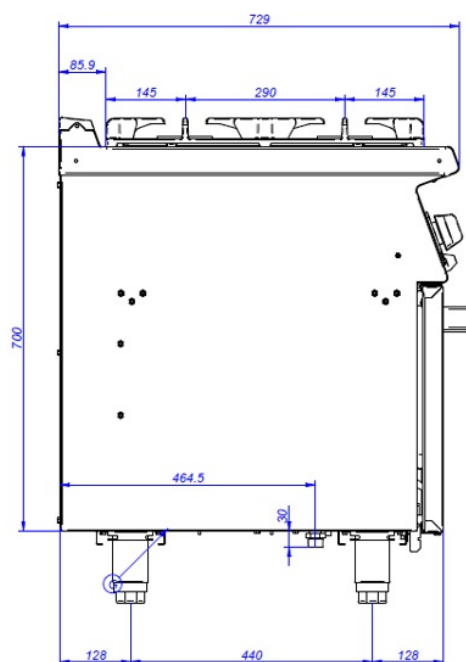
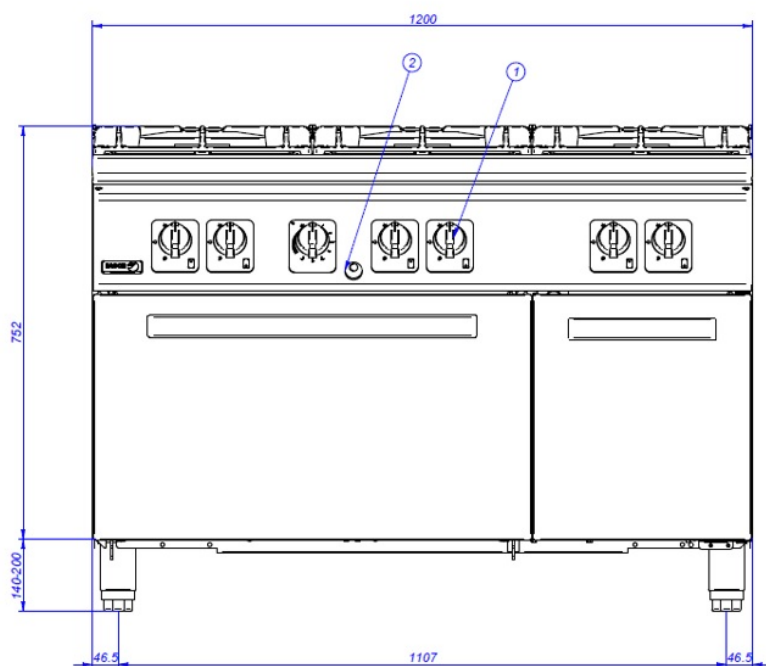

G. Entrada de Gas  
1. Válvula de gas  
2. Pulsador tren de chispas

Gas Inlet  
Gas valve  
Piezoelectric ignitor